

NetSim[®]

Accelerate Network R & D

Underwater Acoustic Networks (UWAN)

A Network Simulation & Emulation Software

By



The information contained in this document represents the current view of TETCOS LLP on the issues discussed as of the date of publication. Because TETCOS LLP must respond to changing market conditions, it should not be interpreted to be a commitment on the part of TETCOS LLP, and TETCOS LLP cannot guarantee the accuracy of any information presented after the date of publication.

This manual is for informational purposes only.

The publisher has taken care in the preparation of this document but makes no expressed or implied warranty of any kind and assumes no responsibility for errors or omissions. No liability is assumed for incidental or consequential damages in connection with or arising out of the use of the information contained herein.

Warning! DO NOT COPY

Copyright in the whole and every part of this manual belongs to TETCOS LLP and may not be used, sold, transferred, copied or reproduced in whole or in part in any manner or in any media to any person, without the prior written consent of TETCOS LLP. If you use this manual you do so at your own risk and on the understanding that TETCOS LLP shall not be liable for any loss or damage of any kind.

TETCOS LLP may have patents, patent applications, trademarks, copyrights, or other intellectual property rights covering subject matter in this document. Except as expressly provided in any written license agreement from TETCOS LLP, the furnishing of this document does not give you any license to these patents, trademarks, copyrights, or other intellectual property. Unless otherwise noted, the example companies, organizations, products, domain names, e-mail addresses, logos, people, places, and events depicted herein are fictitious, and no association with any real company, organization, product, domain name, email address, logo, person, place, or event is intended or should be inferred.

Rev 14.1 (V), Mar 2024, TETCOS LLP. All rights reserved.

All trademarks are property of their respective owner.

Contact us at

TETCOS LLP

214, 39th A Cross, 7th Main, 5th Block Jayanagar,
Bangalore - 560 041, Karnataka, INDIA.

Phone: +91 80 26630624

E-Mail: sales@tetcos.com

Visit: www.tetcos.com

Table of Contents

1	Introduction	4
2	Simulation GUI.....	6
2.1	Create Scenario	6
2.2	Devices specific to NetSim UWAN Library.....	6
2.3	Placement of devices on the grid environment	6
2.4	GUI Configuration Parameters	7
3	Model Features	8
3.1	Acoustic PHY	8
3.1.1	Speed of sound.....	8
3.1.2	Transmit power and Source Level.....	9
3.1.3	Transmission Losses: Thorp Propagation model.....	9
3.1.4	Noise.....	10
3.1.5	Passive Sonar equation	11
3.1.6	MCS, Bit error rate (BER) and Packet error rate	11
3.1.7	Data Rate.....	11
3.1.8	Collisions, Interference and Packet Capture.....	11
3.2	MAC Layer	12
3.2.1	Slotted Aloha.....	12
3.2.2	Slot Length.....	13
3.2.3	Retry count and Back-off.....	14
3.3	IP Addressing, Routing, Queuing and Buffers	14
3.3.1	Multi hop communication.....	14
3.3.2	Queuing and Buffers	15
3.4	Underwater Applications (Network Traffic Generation)	15
3.5	Acoustic Measurements Log	15
4	Featured Examples.....	17
4.1	Throughput and delay variation with distance	17
4.2	Underwater propagation losses and device range	21
4.3	s-Aloha performance with multiple transmit nodes.....	24
5	Limitations	29
6	References.....	29

1 Introduction

Water covers 71% of the Earth. Underwater communication is essential for a wide assortment of applications covering defence, environmental monitoring, commercial exploration, and scientific discovery. Severe attenuation in water limits the range of electromagnetic, optical and magnetic induction-based communications to just a few meters, leaving acoustic communications as the de facto means for wireless data transfer across tens of kilometers.

NetSim's UWAN library enables users to design, simulate and analyze performance of underwater networks that use acoustic communication.

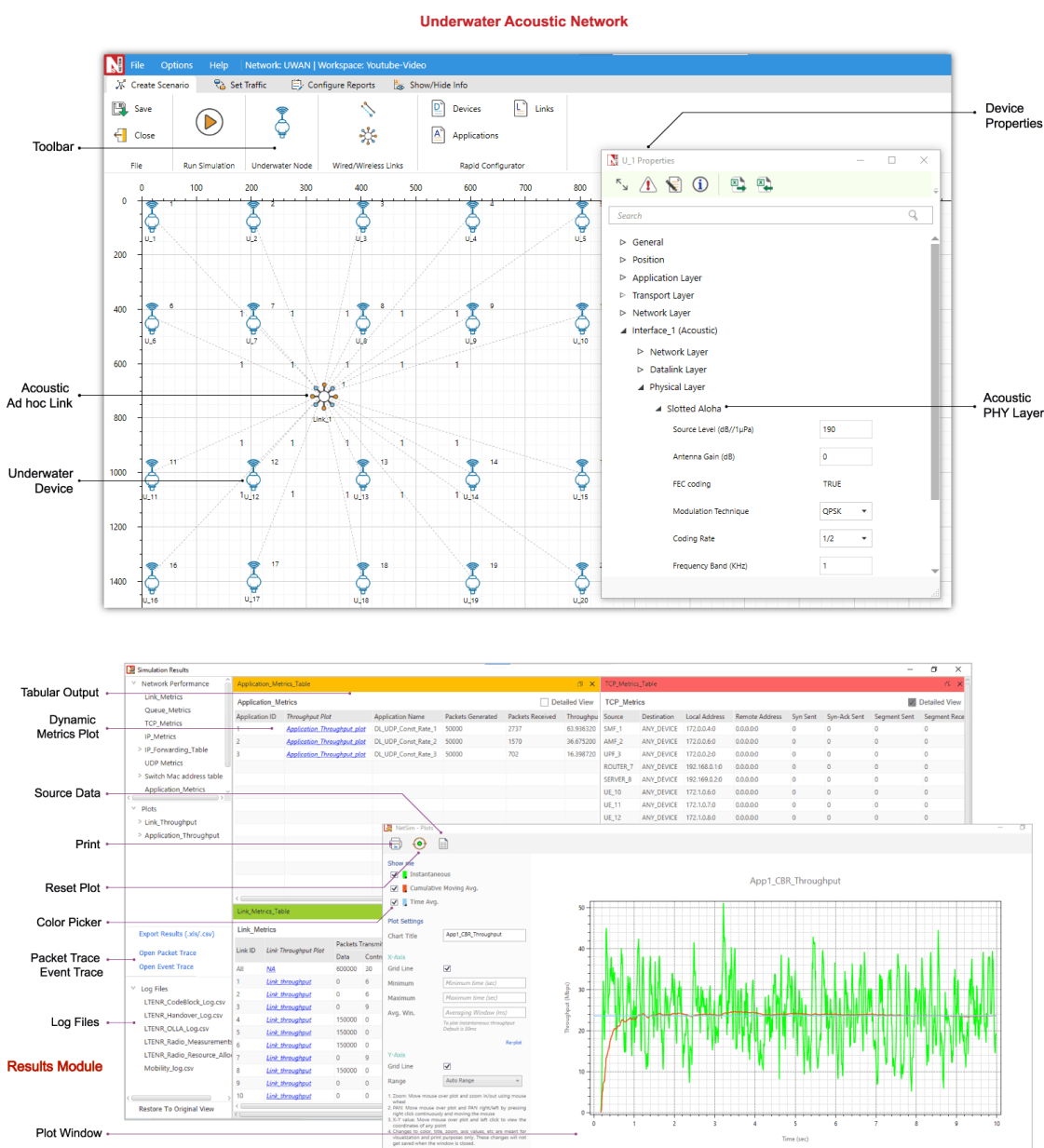

Figure 1-1: NetSim's UWAN design window, the results dashboard, and the plots window

NetSim UWAN simulations are full stack with all 5 layers of the TCP/IP stack being supported as explained below:

- L5, Application: Users can model various kinds of applications as explained in section 3.4. This library supports a new (and default) underwater sensor application - with small packet sizes (order of 10s of Bytes), and large inter-packet arrival times (orders of seconds) - that parallels typical underwater applications.
- L4, Transport: UDP Protocol is supported. TCP is not provided as an option since it is not used in UWAN applications, due to the very low communication bit rates and the high propagation delays.
- L3, Network: Static routing is supported.
- L2, Data Link: Slotted-aloha protocol is supported.
- L1, Physical: Specialized underwater acoustic PHY model and the Thorp propagation model, are supported. Omni directional antennas are assumed.

UWAN is architected to interface with NetSim component 2 (Legacy networks) which provides L2 functionality and component 3 (Advanced switching and routing) which provides the L3 static routing functionality.

The UWAN library is available as Component 12 and is currently available only in NetSim Standard and NetSim Pro versions. Protocol source C code is open to users; it is modular and customizable to help researchers to design and test their own UWAN protocols.

2 Simulation GUI

2.1 Create Scenario

Open NetSim and click **New Simulation** → **Underwater Acoustic Networks** as shown Figure 2-1.

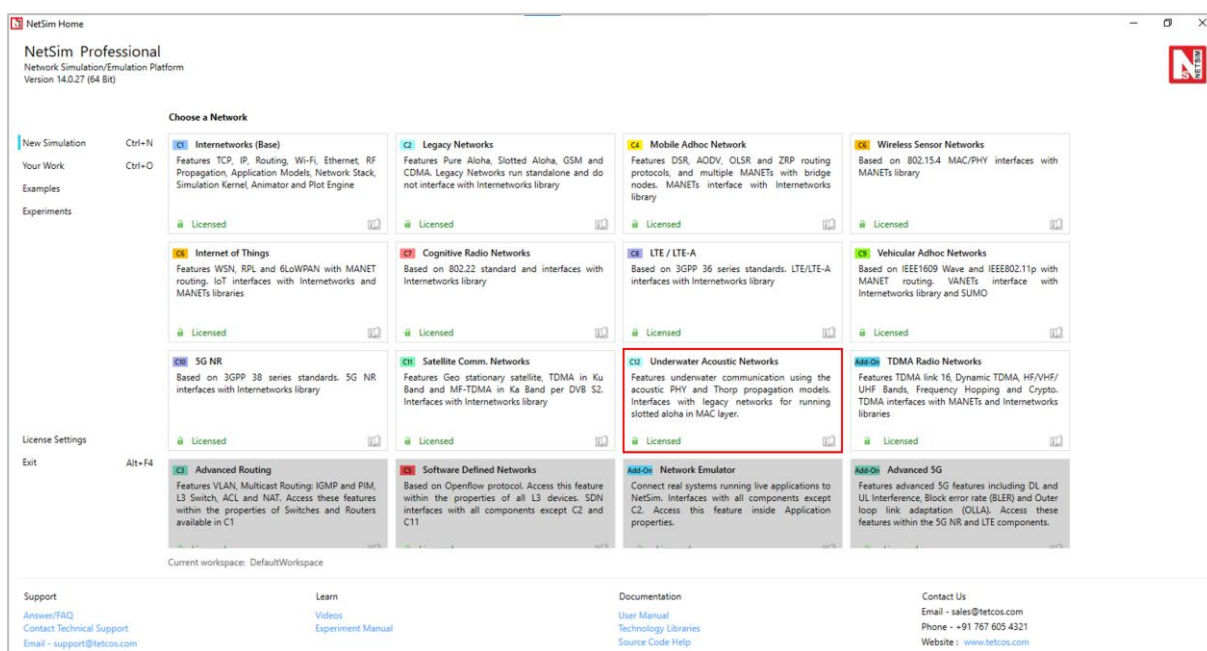

Figure 2-1: NetSim Home Screen

2.2 Devices specific to NetSim UWAN Library

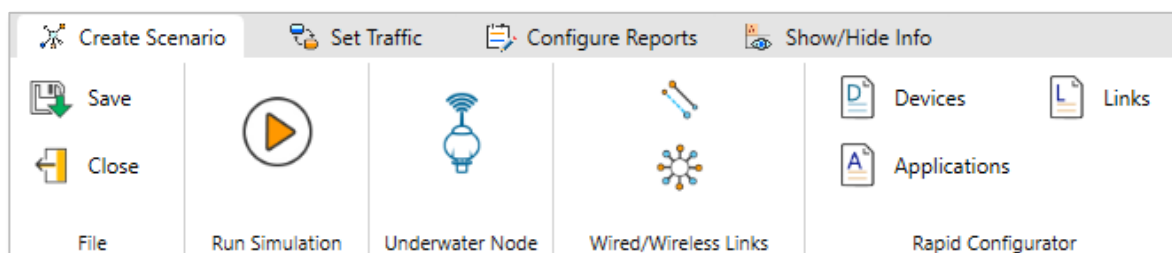

Figure 2-2: The Devices present in the ribbon of NetSim GUI

2.3 Placement of devices on the grid environment

Add an Underwater Device - Click on the **Underwater_Device** icon on the toolbar and place the device in the grid.

2.4 GUI Configuration Parameters

The UWAN parameters can be accessed by right clicking on an Underwater device > selecting Open properties as new window >Interface (Acoustic) Properties → Physical Layers.

UWAN Properties			
Interface (Acoustic) – Physical Layer			
Parameter	Type	Range	Description
Source Level	Local	170 - 225 dB// 1 μ Pa Default: 190	It is the signal level of the transmitter. For converting from electrical transmit power, P_{tx}^{el} in Watts (W), to SL in dB// 1 μ Pa, the following equation can be used $SL = 10 \log_{10}(P_{tx}^{el} [W]) + 170.8$
Antenna Gain (dBi)	Local	-1000 to 1000 dBi	A relative measure of an antenna's ability to direct or concentrate radio frequency energy in a particular direction or pattern. The measurement is typically measured in dBi.
Forward error correction coding (FEC)	Fixed	TRUE	FEC is used for controlling Error-Correcting code, in data over unreliable or noisy communication channels. This is always set to true and the SNR BER calculations factor in FEC.
Modulation	Local	QPSK BPSK FSK 16QAM 64QAM 256QAM	Modulation is the process of varying one waveform in relation to another waveform. It is used to transfer data over an analog channel.
Coding Rate	Local	1/2, 2/3, 3/4, 5/6	It states what portion of the total amount of information is useful (non-redundant). This code rate is typically a fractional number.
Frequency	Local	0.01-1000kHz	The centre frequency in the transmission bandwidth
Data rate (kbps)	Local	0-255 kbps	It is the number of kilo-bits that are conveyed or processed per second
Receiver Sensitivity (dB)	Local	-120 – 0dBm Default: -85 dBm	It is the lowest power level at which the receiver can detect the acoustic signal and demodulate data. The interference threshold is equal to the receive sensitivity as explained in 3.1.8
Bandwidth (Hz)	Local	0-1000 Hz	Bandwidth is the range of frequencies occupied by acoustic signals.

Table 2-1: UWAN Config Properties

3 Model Features

3.1 Acoustic PHY

Underwater acoustic channels are generally recognized as one of the most difficult communication media in use today. The worst properties of radio channels - poor link quality, and high latency - are combined in the acoustic channel. Acoustic propagation is best supported at low frequencies and is characterized by two major factors: attenuation that increases with signal frequency, and the low speed of sound (≈ 1500 m/s).

3.1.1 Speed of sound

The propagation delay model is complex due to the dependency of the speed of sound on the depth of the water. The speed of sound in water, in meters per second, is given by the formula [1].

$$c_{sound} = 1449.05 + 45.7t - 5.21 \times t^2 + 0.23 \times t^3 + (1.333 - 0.126t + 0.009 \times t^2)(S - 35) + 16.3 \times z + 0.18 \times z^2$$

Where t is one-tenth of the temperature of the water in degrees Celsius, z is the average depth in km of the temperature zone and S is the salinity of the water in parts per thousand.

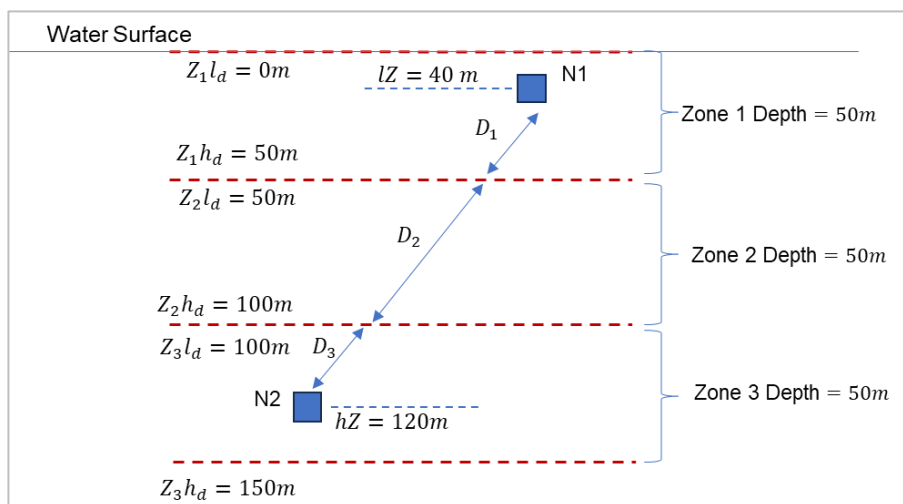

Figure 3-1: An illustration of temperature zones in NetSim where sensor N1 is in zone 1 and sensor N2 is in zone 3.

In the figure, l_d denotes the starting depth and h_d denotes the ending depth of each zone. The zone count (three in this case) and the depth of each zone can be set in NetSim. The average depth in Zone 1 is $\frac{Z_1 l_d + Z_1 h_d}{2} = \frac{0+50}{2} = 25m$, in Zone 2 is $\frac{Z_2 l_d + Z_2 h_d}{2} = \frac{50+100}{2} = 75m$, and in zone 3 is $\frac{Z_3 l_d + Z_3 h_d}{2} = \frac{100+150}{2} = 125m$. The propagation delay is computed separately as

$$\Delta_{tot} = \Delta_1 + \Delta_2 + \Delta_3 = \frac{D_1}{C_{sound}^{zone1}} + \frac{D_2}{C_{sound}^{zone2}} + \frac{D_3}{C_{sound}^{zone3}}$$

3.1.2 Transmit power and Source Level

An acoustic signal propagates as a pressure wave, whose power is measured in Pascals (commonly, in dB relative to a micro-Pascal). NetSim GUI takes source level, SL , as the input, with units $dB//1 \mu Pa$. We may think of $dB//1 \mu Pa$ in acoustics as playing the role of dBm in RF. When referring to the Tx/Rx (acoustic) power it is customary to specify the acoustic intensity value in decibel (dB) relative to the intensity due to 1 micro-pascal (μPa) root mean square (RMS) pressure. In seawater, 1 W of radiated acoustic power creates a sound field of intensity $170.8 dB // 1 \mu Pa$, 1m away from the source. For converting from electrical transmit power, P_{tx}^{el} in Watts (W), to SL in $dB//1 \mu Pa$, the following equation can be used

$$SL = 10 \log_{10}(\xi \times P_{tx}^{el} [W]) + 170.8$$

where ξ is transducer efficiency. The 170.8 dB accounts for the conversion between $dB//1 \mu Pa$ and W . Given below in Table 3-1 are the properties of six commercial and research underwater modems [2]. SL is computed assuming $\xi = 1$.

Underwater modem	P_{tx}^{el} [W]	$SL[dB//1 \mu Pa]$	f [kHz]	Data Rate [kbps]
EvoLogics S2CR 18/34 WiSE	35	186.2407	26	13.90
WHOI Micromodem	48	187.6124	25	5
Teledyne Benthos ATM9XX	20	183.8103	24.50	15.36
LinkQuest UWM4000	7	179.251	17	8.50
Aquatech AQUAModem 1000	20	183.8103	9.75	2
DSPComm AquaComm	1.8	173.3527	23	0.48

Table 3-1: Commercial underwater modems and their specifications

3.1.3 Transmission Losses: Thorp Propagation model

A distinguishing property of acoustic channels is the fact that path loss depends on the signal frequency. This dependence is a consequence of absorption (i.e., transfer of acoustic energy into heat) [3]. The simplest model for acoustic attenuation in water is

$$A(d, f) = d^k \alpha (f)^d$$

Where α : absorption coefficient factor, depends on the sound frequency f , d : Distance, and k : the spreading coefficient defined by geometry. The spreading factor, k , describes the geometry of propagation and is typically $1 \leq k \leq 2$, e.g., $k = 1$, and $k = 2$ correspond to cylindrical and spherical spreading, respectively. $k = 1.5$ is often considered a practical setting. A cylindrical spreading corresponds to cases in which the transmission distance l is much larger than the depth of the ocean. In this case, the ocean bottom and the interface between the ocean and the air act as boundaries for the spreading of acoustic waves. On the other

hand, spherical spreading is considered when the transmission distance is smaller than the depth of the ocean. This type of spreading provides a similar k as the free-space approximation for radio wireless communications [4].

A common empirical formula used for absorption $\alpha(f)$ is Thorp's formula, which for f in kHz is given by [5]

$$10 \log_{10} \alpha(f) = \begin{cases} 0.11 \times \left(\frac{f^2}{1+f^2} \right) + 44 \times \left(\frac{f^2}{4100+f^2} \right) + 2.75 \times 10^{-4} \times f^2 + 0.003 & f \geq 0.4 \\ 0.002 + 0.11 \times \left(\frac{f^2}{1+f^2} \right) + 0.011 \times f^2 & f < 0.4 \end{cases}$$

This output is in db/km . Combining absorption effects and spreading loss, the total attenuation is as follows:

$$10 \log A(d, f) = k \times 10 \log (d_m) + d_{km} \times 10 \log \alpha(f)$$

Here d_m is in distance in meters, $d_{km} = \frac{d_m}{1000}$, and f is in KHz . The Throp model outputs the attenuation in dB.

3.1.4 Noise

The calculation for the ambient noise in the underwater environment is divided into the major factors contributing to the total: turbulence, shipping, wind, and thermal. The following formulae give the noise power [dB] of the four components

$$\begin{aligned} 10 \log N_t(f) &= 17 - 30 \log (f) \\ 10 \log N_s(f) &= 40 + 20 \times (s - 0.5) + 26 \log f - 60 \times \log(f + 0.03) \\ 10 \log N_w(f) &= 50 + 7.5 \times \sqrt{w} + 20 \log f - 40 \log(f + 0.4) \\ 10 \log N_{th}(f) &= -15 + 20 \log f \end{aligned}$$

Where f is frequency in kHz, s is the shipping factor and w is the wind-speed in m/s . The default value for s is 0.5 and for w is 0.

Turbulence noise influences only the very low frequency region, $f < 10 Hz$. Noise caused by distant shipping is dominant in the frequency region $10 Hz - 100 Hz$, and it is modeled through the shipping activity factor s , whose value ranges between 0 and 1 for low and high activity, respectively. Surface motion, caused by wind-driven waves (w is the wind speed in m/s) is the major factor contributing to the noise in the frequency region $100 Hz - 100 kHz$ (which is the operating region of most acoustic systems). Finally, thermal noise becomes dominant for $f > 100 kHz$ [5].

The total noise in linear scale is given as

$$N_{total}^{linear} = N_t^{linear} + N_s^{linear} + N_w^{linear} + N_{th}^{linear}$$

and the total noise in dB domain is $N_{dB}^{total} [dB] = 10 \log_{10}(N_{total}^{linear})$

3.1.5 Passive Sonar equation

NetSim uses the passive sonar equation to compute the SNR at the receiver. The passive sonar equation is written as

$$SNR = SL - TL - (NL - DI)$$

Where SL is the source level, TL is the transmission losses, NL is the noise level and DI is receiver directivity index. NetSim assumes $DI = 0$, and upon appropriate substitutions the equation turns out as

$$SNR [dB] = SL - 10 \log_{10} A(d, f) [dB] - N_{dB}^{total} [dB]$$

On the RHS of the equation, the second term is TL and the final term is the NL .

3.1.6 MCS, Bit error rate (BER) and Packet error rate

Unlike 802.11 or 5G protocols, there are no standards specifying the modulation and coding scheme (MCS) for different received signal powers. Hence MCS is a user settable input parameter. Bit-error-rate (BER) is computed from the received signal to noise ratio (SNR) and the modulation and coding scheme (MCS) set by the user. NetSim assumes that the noise variance is Gaussian and the BER is computed from the standard SNR-BER tables described in the *Propagation Models* technology library manual. Packet error rate (PER) is then calculated from BER based on packet length.

Users who wish to use their own (custom) SNR-BER tables, can modify the `UWAN_Calculate_BER` function in `UWAN.c` file under the UWAN project.

3.1.7 Data Rate

The data rate is set through a GUI parameter; it is not computed by NetSim during simulation. In NetSim, the modulation and coding scheme (MCS) is set by the user in the GUI. This MCS setting does not affect the data rate; it only impacts BER calculations. More information on MCS is provided in section 3.1.6. The implicit assumption is that the user sets the right combination of data rate and MCS.

3.1.8 Collisions, Interference and Packet Capture

Per conventional definition collisions occur when there is simultaneous packet transmission, and these collided packets are assumed failed or lost. In this characterization, when there is simultaneous packet transmission, collisions are assumed to occur whatever the spatial

separation (distance) between nodes and whatever the nodes' transmit powers. Clearly this is an approximation aimed at simplification. In case of simultaneous packet transmissions, it is possible that one (or more) signals have sufficient strength to be decoded by the receiver. Therefore, packets involved a collision can sometimes be successfully received. This phenomenon is known as Packet Capture.

NetSim approximately models Packet Capture considering interference threshold (I_{th}) rather than SINR. If the sum of all interfering signals, at the receiver, is greater than I_{th} then the packet being received (by the receiver) is marked as collided. Else, if the total interference power is less than I_{th} the packet succeeds despite ongoing simultaneous transmission. To elaborate, we start by denoting Underwater device as UWD and let UWD_{tx} be transmitting a packet to UWD_{rx} , while UWD_I^n be n other $UWDs$ that are transmitting at the same time. These are marked with subscript I since these transmissions would interfere with the UWD_{tx} to UWD_{rx} transmission. NetSim computes the received signal power at UWD_{rx} from all the other n transmitting $UWDs$. All these powers are summed up and is equal to $\sum_{j=1}^n P_r^j$ where P_r^j is the received power of interfering UWD_I^j at UWD_{rx} . This summed interfering power, $\sum_{j=1}^n P_r^j$, is compared against an inference threshold I_{th} which is equal to the receive sensitivity (set to $-85dB$ by default in NetSim). If total interfering power is greater than the interference threshold, then the packet being transmitted from UWD_{tx} to UWD_{rx} is marked as collided. Should the total interfering power be less than $-85dB$, the packet being transmitted from UWD_{tx} to UWD_{rx} is successfully received at UWD_{rx} .

An exact SINR based packet capture model (rather than the approximate Interference threshold-based packet capture model) is under development and is expected by the next release.

3.2 MAC Layer

NetSim currently only supports slotted Aloha in the MAC layer.

The reason for not supporting a contention-based protocol is: the basic principle of carrier sensing multiple access — that a node should transmit only if it hears no ongoing transmissions — is compromised in an acoustic channel where the packets propagate slowly, and the fact that none are overheard does not mean that some are not present in the channel [3].

3.2.1 Slotted Aloha

NetSim UWAN stack runs slotted Aloha (s-Aloha) in the MAC layer. s-Aloha is decentralized medium access control protocol that does not perform carrier sensing. Data transmission by

devices is synchronized to timeslots. All devices are assumed to be perfectly synchronized to one another and to the timeslots.

In NetSim's s-Aloha implementation, the transmitter sends the next packet only after the current packet has either been received or errored. The knowledge of a packets successful or erroneous reception (due to collision or channel error) is known by the receiver only after it receives the complete packet. In case of unicast applications, the total time taken for the reception of a packet after the transmission commences is equal to the transmission time T_{tx} plus the propagation delay Δ . It is assumed in NetSim, that the transmitter knows packet status at the exact time that the receiver knows the packet status. Hence the transmitter gets to know if a packet is successful or errored only $(T_{tx} + \Delta)$ seconds after commencing transmission. If the packet is errored the transmitter will retransmit (depending on the retry count set by the user in the UI) the packet; if the packet is successful, the transmitter will send the next packet.

3.2.2 Slot Length

Due to the long propagation delays user should take care to set the slot size in the GUI. This is a global parameter applicable to all UWAN devices. As a starting step, estimate the transmission time, T_{tx} which would be

$$T_{tx}(\mu s) = \frac{(L_{pkt} + OH) \times 8}{PHYRate}$$

where L_{pkt} is the application layer packet size, OH is the overheads of all layers which is equal to 28B, and $PHYRate$ is the data rate set in the PHY layer. Next, the propagation delay, Δ is computed as $\Delta = \frac{d}{c_{sound}}$, where d is the distance between the transmitter and the receiver.

Thus, the ideal slot length should be

$$L_{slot} = \frac{(L_{pkt} + OH) \times 8}{PHYRate} + \frac{d}{C_{sound}}$$

Example: Let us consider the default values of $L_{pkt} = 14B$ and $PHYRate = 20 Kbps$ which leads to $T_{tx} = 16,800 \mu s$. Then using $t = \frac{25}{10} = 2.5$, $z = 50$, and $S = 35$ - where t is one-tenth of the temperature of the water in degrees Celsius, z is the depth in meters and S is the salinity of the water - we get (per earlier section 3.1) $c_{sound} = 2799.33 m/s$. When the transmitter receiver distance is $d = 2km$, the propagation delay, $\Delta = \frac{2 \times 10^3}{2799.33} = 714,456.4 \mu s$. Substituting all these, we see that the ideal slot length (when $d = 2km$) would be

$$L_{slot} = T_{tx} + \Delta = 16,800 + 714,456.4 = 731,256.4 \mu s = 0.73 s$$

Considering a slot length of $731,256.4 \mu s$, we see if one packet exactly fits one slot then the predicted saturation throughput would be

$$\theta_{sat} = \frac{(L_{pkt} \times 8)}{L_{slot}} = \frac{(14 \times 8)}{731256.4 \times 10^{-6}} = 153 \text{ bps}$$

NOTE:

- *If different Tx-Rx pairs are at different distances, then users should set the slot length based on the largest Tx-Rx distance i.e., based on the largest propagation delay.*
- *NetSim limitation of not modeling link-level (reverse) ACKs can be overcome by adding additional time in the slot length to account for ACK transmissions. This work around, however, does not account for ACK failures.*

3.2.3 Retry count and Back-off

An important MAC layer parameter is Retry Count. This is a user-configurable parameter. A transmitter running s-Aloha retries when packets received (at the receiver) are in error. Recall here the NetSim assumption that the transmitter knows the packet status at the receiver.

The maximum number of times the transmitter retries is equal to Retry Count. Once this limit is hit the transmitter drops the packet. For example, if the Retry Count is 3, and if a packet fails in 1st transmission and in the 1st, 2nd and 3rd retransmission, then that packet is dropped by the transmitter.

The transmitter backs-off before each retry. The back off time (in slots) is a random number chosen from $[0, CW - 1]$ where CW is the contention window and is equal to 2^n , where n is the current value of the Retry Count. Unlike the 802.11 protocols, in s-Aloha, the transmitter does not back off before the 1st transmission.

The description above pertains to the behavior of unicast packets. For broadcast applications, the procedure varies as follows:

- Prior to the first transmission, the transmitter implements a back-off. The duration of this back-off is randomized, selected from a range of 0 to 7 slots.
- Broadcast packets do not undergo re-transmissions.

3.3 IP Addressing, Routing, Queuing and Buffers

Addressing for UWAN devices is IP based. The IP addresses are automatically set by NetSim.

3.3.1 Multi hop communication

The fact that the acoustic bandwidth depends on the distance has important implications for the design of underwater networks. Specifically, it makes a strong case for multihopping, since

dividing the total distance between a source and destination into multiple hops enables transmission at a higher bit rate over each (shorter) hop [5].

NetSim currently supports static routing for multi-hop communication. Ad hoc routing is not yet available. While, no routing configuration is required for single hop communication, static routing needs to be configured for multi-hop communication. Static routing configuration is explained in the *Internetworks* technology library manual, Section: Configuring Static Routing in NetSim.

3.3.1.1 SDN based Routing

Software defined networking (SDN) can be enabled in the application layer of UWAN devices. Complete details of SDN GUI interface and SDN working is given in Software Defined Networks technology library manual.

This feature will be available in Component 5: Software Defined Networks is licensed along with Component 12: UWAN.

3.3.2 Queuing and Buffers

Queuing in UWAN devices is on a first-in-first-out (FIFO) basis. For example, if a UWAN device is acting as both a source of traffic and a relay, then source traffic and relay traffic would arrive at the device's (MAC) buffer. The traffic would be queued and served per FIFO working. UWAN devices in NetSim have infinite (MAC) buffers.

3.4 Underwater Applications (Network Traffic Generation)

Users can model various kinds of applications (that generate network traffic). These include CBR, File transfer, Video etc. Typical examples include of transfers from one underwater device to another include (i) transferring a file (ii) transmitting very low bit rate video (iii) generating a constant-bitrate (CBR) application for theoretical performance studies etc. Details of the different application models are provided in Section 6 of the NetSim user manual.

3.5 Acoustic Measurements Log

NetSim Acoustic Measurements Log csv file records pathloss, distance, transmitted power, received power, total noise, SNR, BER etc. This log can be used to understand the effects of the acoustic propagation model and the impact of varying channel conditions.

This log file can be enabled from the Options->Enable Logs as explained in section 8.6 of NetSim User Manual.

The Acoustic_Measurements_Log.csv file will contain the following information:

- Time in milliseconds
- Transmitter Name
- Receiver Name
- Distance between transmitter and receiver in meters.
- Transmitter Power in dB/μPa
- Pathloss in dB/μPa
- Total Noise in dB/μPa
- SNR in dB
- Receiver Power in dB/μPa
- BER

The log file can be accessed from the Simulations Results Window by clicking Logs option in the left pane.

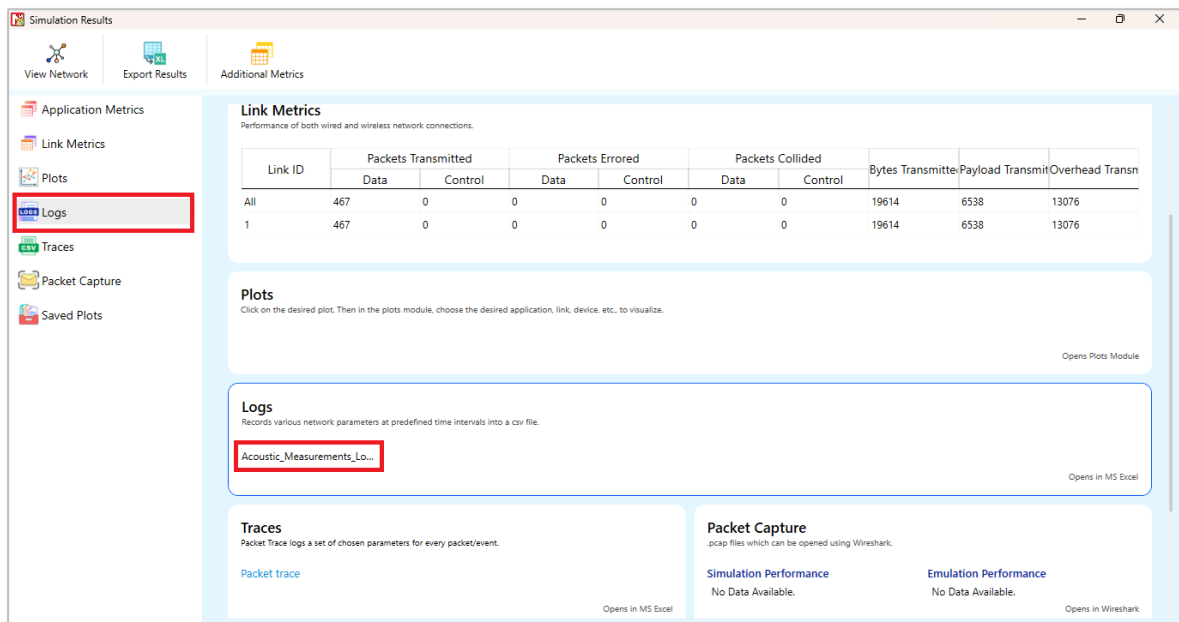

Figure 3-2: Acoustic_Measurements_Log.csv file highlighted in the Results window.

Time(ms)	Transmitter Name	Receiver Name	Distance(m)	Tx Power(dB/1 micro Pa)	Pathloss(dB/1 micro Pa)	Total Noise(dB/1 micro Pa)	SNR(dB)	Rx Power(dB/1 micro Pa)	BER
127.141435	UNDERWATER_DEVICE_1	UNDERWATER_DEVICE_3	308.882226	190	0	45.372625	144.62738	190	0
341.093035	UNDERWATER_DEVICE_1	UNDERWATER_DEVICE_3	308.882226	190	0	45.372625	144.62738	190	0
555.044635	UNDERWATER_DEVICE_1	UNDERWATER_DEVICE_3	308.882226	190	0	45.372625	144.62738	190	0
768.996235	UNDERWATER_DEVICE_1	UNDERWATER_DEVICE_3	308.882226	190	0	45.372625	144.62738	190	0
982.947835	UNDERWATER_DEVICE_1	UNDERWATER_DEVICE_3	308.882226	190	0	45.372625	144.62738	190	0
1196.89944	UNDERWATER_DEVICE_1	UNDERWATER_DEVICE_3	308.882226	190	0	45.372625	144.62738	190	0
1410.85104	UNDERWATER_DEVICE_1	UNDERWATER_DEVICE_3	308.882226	190	0	45.372625	144.62738	190	0
1624.80264	UNDERWATER_DEVICE_1	UNDERWATER_DEVICE_3	308.882226	190	0	45.372625	144.62738	190	0
1838.75424	UNDERWATER_DEVICE_1	UNDERWATER_DEVICE_3	308.882226	190	0	45.372625	144.62738	190	0
2052.70584	UNDERWATER_DEVICE_1	UNDERWATER_DEVICE_3	308.882226	190	0	45.372625	144.62738	190	0
2266.65744	UNDERWATER_DEVICE_1	UNDERWATER_DEVICE_3	308.882226	190	0	45.372625	144.62738	190	0
2480.60904	UNDERWATER_DEVICE_1	UNDERWATER_DEVICE_3	308.882226	190	0	45.372625	144.62738	190	0
2694.56064	UNDERWATER_DEVICE_1	UNDERWATER_DEVICE_3	308.882226	190	0	45.372625	144.62738	190	0
2908.51224	UNDERWATER_DEVICE_1	UNDERWATER_DEVICE_3	308.882226	190	0	45.372625	144.62738	190	0
3122.46384	UNDERWATER_DEVICE_1	UNDERWATER_DEVICE_3	308.882226	190	0	45.372625	144.62738	190	0
3336.41544	UNDERWATER_DEVICE_1	UNDERWATER_DEVICE_3	308.882226	190	0	45.372625	144.62738	190	0
3550.36704	UNDERWATER_DEVICE_1	UNDERWATER_DEVICE_3	308.882226	190	0	45.372625	144.62738	190	0
3764.31864	UNDERWATER_DEVICE_1	UNDERWATER_DEVICE_3	308.882226	190	0	45.372625	144.62738	190	0

Figure 3-3: Acoustic_Measurements_Log.csv file

4 Featured Examples

The configuration files (scenario, settings and other related files) of the examples discussed in this section are not in NetSim's UI (under built in examples) due to the large number of configuration files present (700+). Users can download the files from NetSim's UWAN git-repository.

<https://github.com/NetSim-TETCOS/UWAN-Experiments-and-Measurements-v14.0/archive/refs/heads/main.zip>

1. Click on the link given and download UWAN Experiments
2. Extract the zip folder. The extracted project folder consists of a NetSim Experiments file (UWAN experiments and measurements.netsimexp). How to import the workspace is explained in section 4.9.2 in NetSim User Manual.

4.1 Throughput and delay variation with distance

In this example, we understand how UWAN throughput and delay varies as the distance between 1 transmitter and 1 receiver is varied. Even with *No pathloss* the throughput in UWAN varies with Tx-Rx distance which is not the case in terrestrial RF based transmissions. The two parameters that affect throughput and delay are the speed of sound and the slot length of s-Aloha. The speed of sound in water is given by the formula

$$c_{sound} = 1449.05 + 45.7t - 5.21 \times t^2 + 0.23 \times t^3 + (1.333 - 0.126t + 0.009 \times t^2)(S - 35) + 16.3 \times z + 0.18 \times z^2$$

where t is one-tenth of the temperature of the water in degrees Celsius, z is the depth in km and S is the salinity of the water in ppt. Then using $t = \frac{25}{10} = 2.5$, $z = 50$, and $S = 35$ - where t is one-tenth of the temperature of the water in degrees Celsius, z is the depth in meters and S is the salinity of the water - we get $c_{sound} = 2799.33 \text{ m/s}$. When the transmitter receiver distance is $d = 2 \text{ km}$, the propagation delay, $\Delta = \frac{2 \times 10^3}{2799.33} = 714,456.4 \mu\text{s}$

Next, as explained in section 3.2.2, we consider ideal slot lengths for different transmitter receiver distances. In the case when $d_{Rx}^{Tx} = 2 \text{ km}$ the slot length turns out as

$$L_{slot} = T_{tx} + \Delta = 16,800 + 714,456.4 = 731,256.4 \mu\text{s} = 0.73$$

Table 4-4 shows the ideal slot length settings for $d_{Rx}^{Tx} = 4 \text{ km}$ and $d_{Rx}^{Tx} = 6 \text{ km}$.

Network setup:

- Create a scenario with 2 Underwater Devices

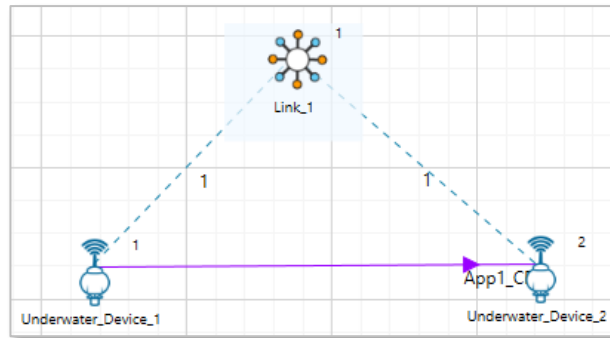

Figure 4-1: Network Scenario. Two underwater devices connected via an acoustic ad hoc link

- In case #1, distance between the underwater devices is set to be 2km. In case #2 the distance is 4km, while in case #3 it is set to 6 km
- Channel characteristics as NO_PATHLOSS

Device Configuration:

Device > Interface (ACOUSTIC) > Datalink Layer	
Slot Length(μs)	16800
Device > Interface (ACOUSTIC) > Physical Layer	
Source Level (dB//1μPa)	200
Modulation	QPSK
Data Rate (kbps)	20

Table 4-1: Device properties set for this example

Application Configuration:

We run simulations for different traffic generation rates. The generation rate depends on the inter-packet arrival time – a GUI input in NetSim – in the following way

$$Generation\ Rate\ (Mbps) = \frac{Packet\ Size\ (Bytes) \times 8}{Interarrival\ Time\ (\mu s)}$$

Application Properties		
Application Method	App1_CBR	
Source ID	1	
Destination ID	2	
Packet Size (Bytes)	14	
	Inter arrival Time (μs)	Generation rate (bps)
Case-1	4480000	25
	2240000	50
	1120000	100
	896000	125
	746666.6666	150
	640000	175
	560000	200
Case-2	5600000	20
	2800000	40

	1866666.6666	60
	1400000	80
	1120000	100
Case-3	5600000	20
	3733333.333	30
	2800000	40
	2240000	50
	1866666.6666	60
	1600000	70

Table 4-2: Application properties for the different samples in each case studied in this example

- Click on Packet Trace option and select the Enable Packet Trace check box.
- Click on Logs option and Enable Acoustic Measurements Log.
- Run the Simulation for 100 sec.

Theoretical Predictions

The predicted propagation delay when the speed of sound $c_{sound} = 2799.33 \text{ m/s}$ is

Distance between devices	Propagation delay (Δ in μs)
2km	714456.4
4km	1428912.7
6km	2143369.1

Table 4-3: Theoretically predicted propagation delay for different Tx-Rx distances

Transmission delay and Saturation Throughput

Considering a slot length of $731,256.4 \mu\text{s}$, we see that one packet exactly fits one slot and hence the predicted saturation throughput would be

$$\theta_{sat}^{2km} = \frac{(L_{pkt} \times 8)}{L_{slot}} = \frac{(14 \times 8)}{731256.4 \times 10^{-6}} = 153 \text{ bps}$$

Proceeding similarly for 4 km and 6 km, the predictions for saturation throughput are

Distance between devices	Slot Length (L_{slot})	Saturation Throughput (θ_{sat} in bps)
2 km	731256.4	153
4 km	1445712.7	77
6 km	2160169.1	52

Table 4-4: Ideal slot lengths and theoretically predicted saturation throughputs (θ_{sat}) for different Tx-Rx distances

Simulation results

We calculate of queuing delay, transmission delay, propagation delay from the packet trace. The steps are:

- Open Packet Trace file using the Open Packet Trace option available in the Simulation Results window.
- The difference between the PHY LAYER ARRIVAL TIME(US) and the MAC LAYER ARRIVAL TIME(US) will give us the delay of a packet. (Refer Figure 4-2)

$$\text{Queuing Delay } (\mu\text{s}) = \text{PHYSICAL LAYER ARRIVAL TIME}(\mu\text{s}) - \text{MAC LAYER ARRIVAL TIME } (\mu\text{s})$$

Source ID	Destination ID	Transmitter ID	Receiver ID	App Layer Arrival Time (US)	Trx Layer Arrival Time (US)	Nw Layer Arrival Time (US)	Mac Layer Arrival Time (US)	Phy Layer Arrival Time (US)	Queuing Delay
1	NODE-1	NODE-2	NODE-1	4480000	4480000	4480000	4480000	4485600	5600
2	NODE-1	NODE-2	NODE-1	8960000	8960000	8960000	8960000	8971200	11200
3	NODE-1	NODE-2	NODE-1	13440000	13440000	13440000	13440000	13440000	0
4	NODE-1	NODE-2	NODE-1	17920000	17920000	17920000	17920000	17925600	5600
5	NODE-1	NODE-2	NODE-1	22400000	22400000	22400000	22400000	22411200	11200
6	NODE-1	NODE-2	NODE-1	26880000	26880000	26880000	26880000	26880000	0
7	NODE-1	NODE-2	NODE-1	31360000	31360000	31360000	31360000	31365600	5600
8	NODE-1	NODE-2	NODE-1	35840000	35840000	35840000	35840000	35841200	11200
9	NODE-1	NODE-2	NODE-1	40320000	40320000	40320000	40320000	40320000	0
10	NODE-1	NODE-2	NODE-1	44800000	44800000	44800000	44800000	44805600	5600
11	NODE-1	NODE-2	NODE-1	49280000	49280000	49280000	49280000	49291200	11200
12	NODE-1	NODE-2	NODE-1	53760000	53760000	53760000	53760000	53765600	5600
13	NODE-1	NODE-2	NODE-1	58240000	58240000	58240000	58240000	58245600	5600
14	NODE-1	NODE-2	NODE-1	62720000	62720000	62720000	62720000	62731200	11200
15	NODE-1	NODE-2	NODE-1	67200000	67200000	67200000	67200000	67200000	0
16	NODE-1	NODE-2	NODE-1	71680000	71680000	71680000	71680000	71685600	5600
17	NODE-1	NODE-2	NODE-1	76160000	76160000	76160000	76160000	76171200	11200
18	NODE-1	NODE-2	NODE-1	80640000	80640000	80640000	80640000	80640000	0
19	NODE-1	NODE-2	NODE-1	85120000	85120000	85120000	85120000	85125600	5600
20	NODE-1	NODE-2	NODE-1	89600000	89600000	89600000	89600000	89611200	11200
21	NODE-1	NODE-2	NODE-1	94080000	94080000	94080000	94080000	94080000	0
22	NODE-1	NODE-2	NODE-1	98560000	98560000	98560000	98560000	98565600	5600

Figure 4-2 : Screen shot of NetSim trace showing the Queuing Delay column

- Now, calculate the mean queuing delay by taking the average of the queuing delays of all the packets. This is nothing but the column average. (Refer Figure 4-2)
- Similarly, users can get the Mean Transmission Delay and Mean Propagation Delay from the packet trace using the formulas

$$\text{Transmission Delay } (\mu\text{s}) = \text{PHY LAYER START TIME}(\mu\text{s}) - \text{PHY LAYER ARRIVAL TIME}(\mu\text{s})$$

$$\text{Propagation Delay } (\mu\text{s}) = \text{PHY LAYER END TIME}(\mu\text{s}) - \text{PHY LAYER START TIME}(\mu\text{s})$$

	Generation Rate (bps)	Throughput (bps)	Delay (μs)	Mean Propagation Delay(μs)	Mean Transmission Delay(μs)	Mean Queuing Delay(μs)
Case #1: Distance between underwater devices is 2km	25	26	736612.9	714456.4	16800	5356.52
	50	50	736856.4	714456.4	16800	5600
	100	100	736793.4	714456.4	16800	5537.08
	125	124	736856.4	714456.4	16800	5600
	150	149	738666.9	714456.4	16800	7410.53
	175	151	7377656.4	714456.4	16800	6646400
Case #2: Distance between underwater devices is 4km	20	20	1451313	1428912.7	16800	5600
	40	40	1451313	1428912.7	16800	5600
	60	59	1453285	1428912.7	16800	7572.33
	80	76	3509313	1428912.7	16800	2063600
	100	76	12889313	1428912.7	16800	11443600
Case #3: Distance between underwater devices is 6km	20	20	2165769	2143369.1	16800	5600
	30	30	2167636	2143369.1	16800	7466.67
	40	39	2165609	2143369.1	16800	5440
	50	49	2165769	2143369.1	16800	5600
	60	52	8922169	2143369.1	16800	6762000
	70	52	14922169	2143369.1	16800	12762000

Table 4-5: Tabulated results (throughput and delays) for 3 different Tx-Rx distances

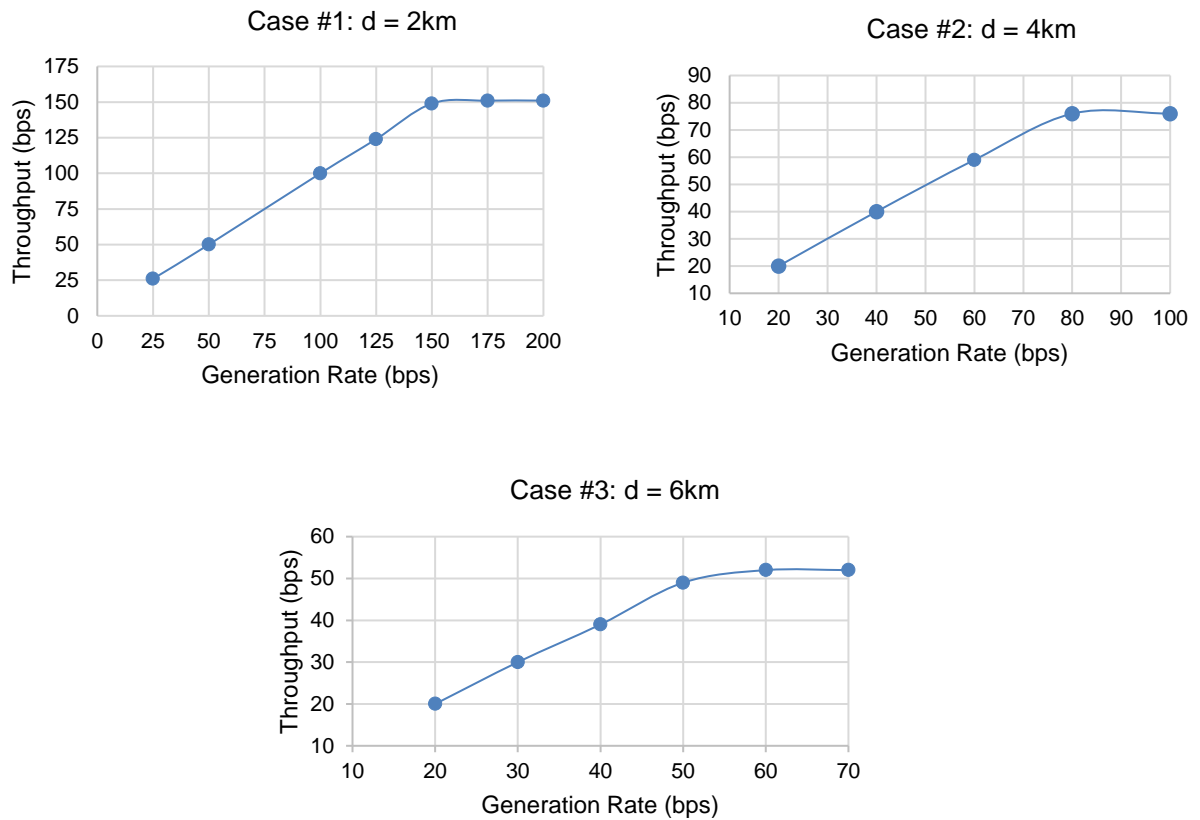

Figure 4-3: Throughput vs. Generation rate plotted for Tx-Rx distances of 2km, 4km and 6km based on earlier tables

From Table 4-5, we see that the propagation delays from simulation match predictions in Table 4-3. Then from we observe that saturation throughput (the Y axis value once the curve flattens) matches prediction.

Distance between devices	Saturation Throughput. Predicted (θ_{sat} in bps)	Saturation Throughput. Simulation (θ_{sat} in bps)
2 km	153	151
4 km	77	76
6 km	52	52

Table 4-6: NetSim UWAN Simulation results vs. theoretical prediction of saturation throughput, for different Tx-Rx distances

4.2 Underwater propagation losses and device range

In this example, we understand the Thorp propagation model, the sources of under-water noise, the passive sonar equation and how device range can be estimated based on received SNR. Refer to section 3.1 for the underlying theory on signal level, transmission losses, and the passive sonar equation.

Network setup

- Create a scenario with two underwater devices

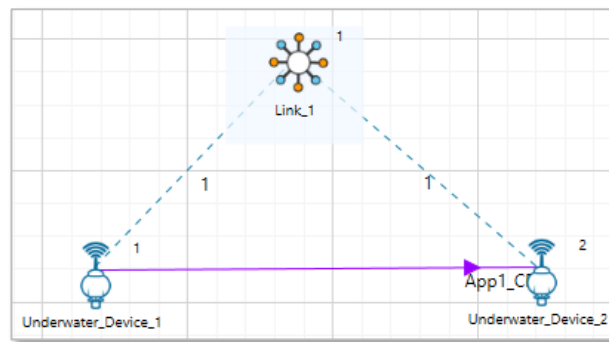

Figure 4-4: Network Scenario

- Channel characteristics as PATHLOSS_ONLY
- Change the Following parameters, Right Click on Underwater_Device_1 → Properties

Device Properties > Physical Layer	
Source Level ($dB//1\mu Pa$)	190.8, 187.78, 183.91
Data Rate (kbps)	20
Modulation Technique	QPSK, BPSK, FSK, 16QAM, 64QAM, 256QAM

Table 4-7: Device Properties

- Create a CBR Application with Default Properties with Source ID as 1 and Destination ID as 2.
- Click on Logs option and Enable Acoustic Measurements Log.
- Run the Simulation for 1000 sec.

Analytical computations

In the Thorp model, the db/km attenuation is given by.

$$10 \log_{10} \alpha(f) = \begin{cases} 0.11 \times \left(\frac{f^2}{1+f^2} \right) + 44 \times \left(\frac{f^2}{4100+f^2} \right) + 2.75 \times 10^{-4} \times f^2 + 0.003 & f \geq 0.4 \text{ kHz} \\ 0.002 + 0.11 \times \left(\frac{f^2}{1+f^2} \right) + 0.011 \times f^2 & f < 0.4 \text{ kHz} \end{cases}$$

For this example, substituting $f = 20$, we get $10 \log_{10} \alpha(f) = 4.133 \text{ db/km}$, we see that the total pathloss is

$$10 \log A(d, f) = k \times 10 \log (d_m) + d_{km} \times 10 \log \alpha(f)$$

Using input parameters K (*spread coefficient*) = 2, $f = 20 \text{ kHz}$ and distance between the source and destination, $d = 18 \text{ km}$, and we get the total transmission loss, TL , as

$$TL = 10 \log A(d, f) = 159.51 \text{ dB}$$

Next, we turn to noise level NL . The turbulence, shipping, wind, and thermal, noise level in dB is given by

$$10 \log N_t(f) = 17 - 30 \log(f)$$

$$10 \log N_s(f) = 40 + 20 \times (s - 0.5) + 26 \log f - 60 \times \log(f + 0.03)$$

$$10 \log N_w(f) = 50 + 7.5 \times \sqrt{w} + 20 \log f - 40 \log(f + 0.4)$$

$$10 \log N_{th}(f) = -15 + 20 \log f$$

Substituting $f = 20 \text{ kHz}$, shipping factor $s = 0.5$, surface windspeed $w = 0 \text{ m/s}$, we get $N_t = -22.03 \text{ dB}$, $N_s = -4.27 \text{ dB}$, $N_w = 23.63 \text{ dB}$, and $N_{th} = 11.02 \text{ dB}$. As explained in section 3.1.4 we see that wind noise has the most impact. After adding these noises in the linear scale and then converting back to dB, Total noise, $N_{Total}^{dB} = 23.87$. From the passive sonar equation

$$SNR = SL - TL - (NL - DI)$$

Substituting we get

$$SNR = 190.80 - 159.51 - (23.87 - 0) = 1.41 \text{ dB}$$

Results: Packet Error Rate vs Distance

For the above SNR, we plot PER vs. distance for different modulation schemes given default packet size of 14B.

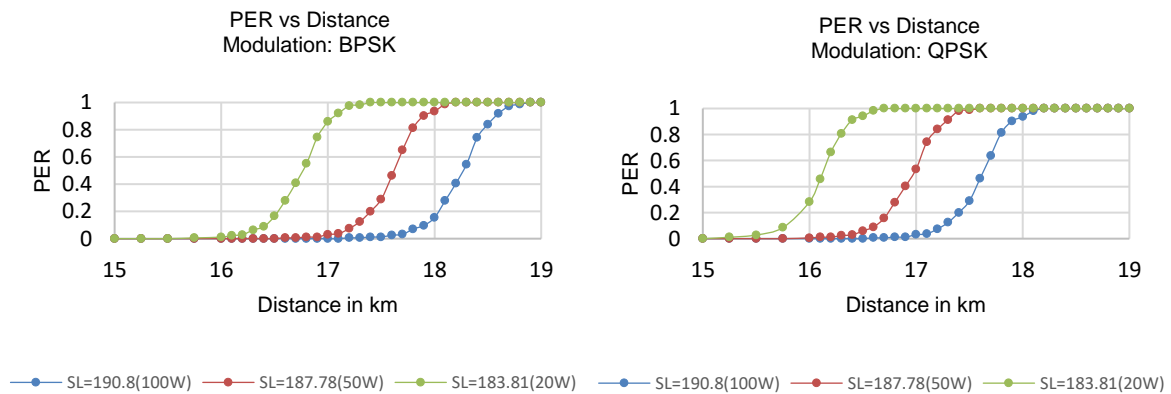

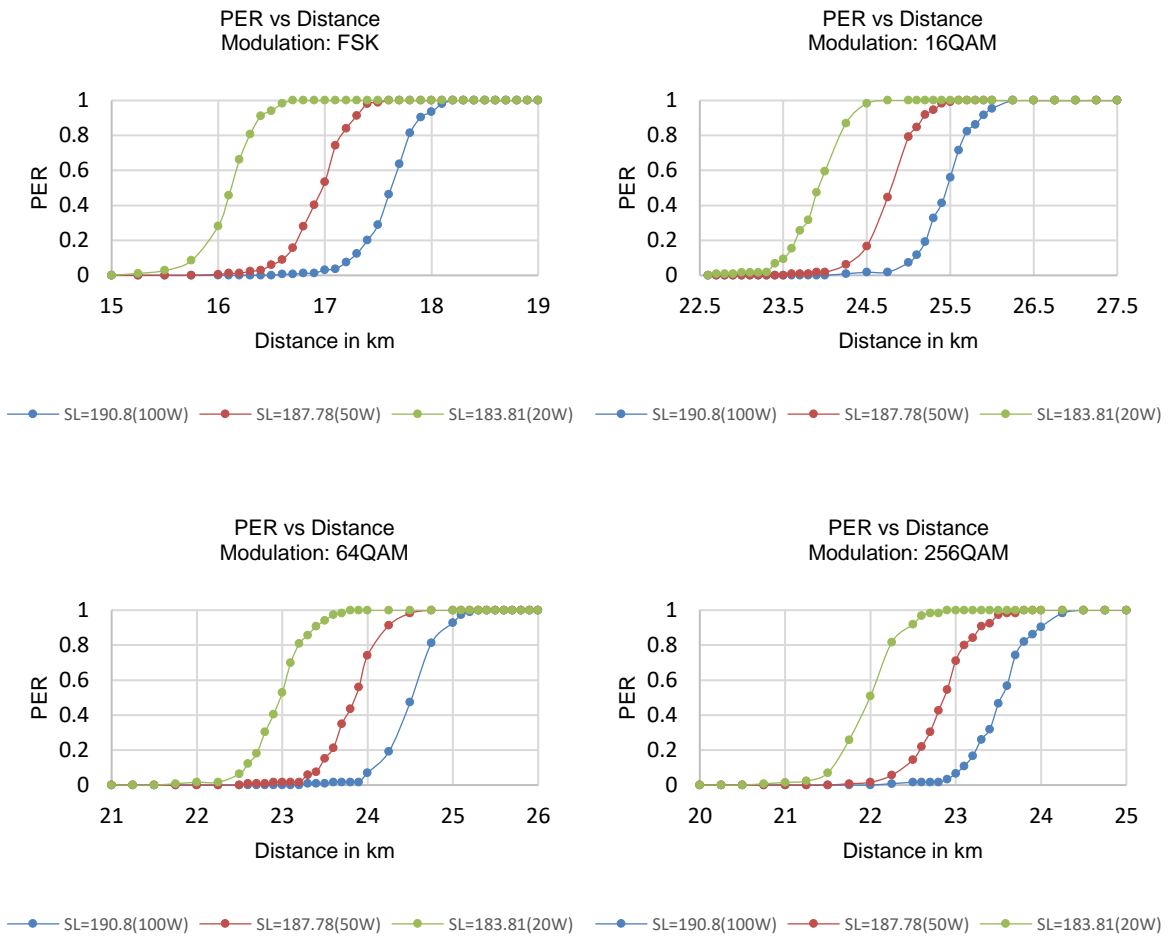

Generally, range is defined as the Tx-Rx distance at which the PER is 10 %. From these plots we can determine a device’s range. In summary, we see how the device range is dependent on Source Level, Noise, MCS and packet size.

4.3 s-Aloha performance with multiple transmit nodes

Network setup

We consider three scenarios as shown in the figure below, with 2, 3 and 4 transmitting nodes.

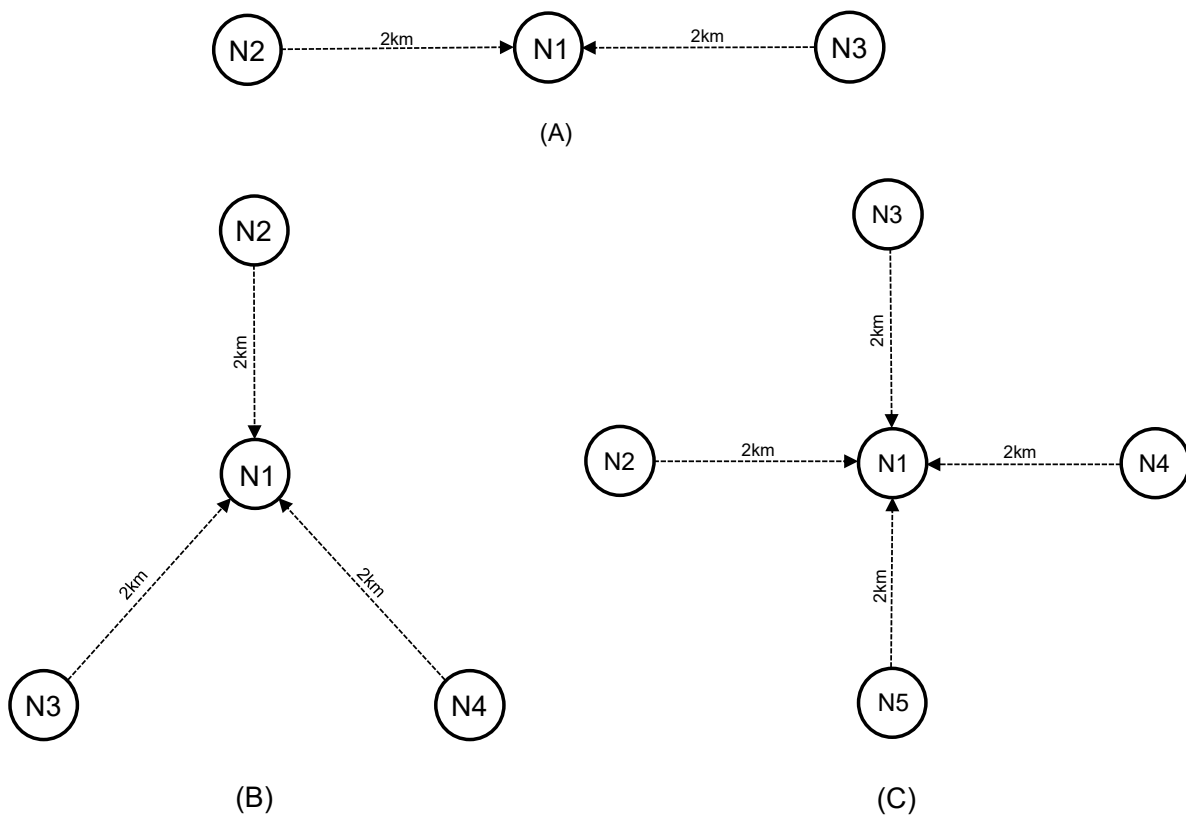

Figure 4-5: Simulation scenarios with 2 transmitting nodes in (A), 3 transmitting nodes in (B) and 4 transmitting nodes in (C). In all cases there is a single receiver.

Properties

Then we set the UWAN device properties as shown below

Device Properties	
Device > Interface (ACOUSTIC) > Datalink Layer	
Retry Limit	0,4,6
Slot Length(μs)	741256.4
Device> Interface (ACOUSTIC) > Physical Layer	
Source Level (dB//1μPa)	190.8
Modulation	QPSK
Data Rate (kbps)	20

Table 4-8: UWAN Device Properties

- Here, we set the Slot Time as 741256.4 μs, which is the ideal value of 731256.4 μs plus a guard interval of 10,000 μs
- Create a CBR Application from the source nodes (2, 3, 4 and 5 per the cases) to the destination (Node 1) with a packet size of 14 bytes and Inter arrival time as 560000μs.
- Click on Logs option and Enable Acoustic Measurements Log.
- Run the Simulation for 10000sec.

Results

We observe throughputs from network metrics and packets transmitted and packets collided from the Link Metrics. We collision probability as $P_c = \frac{\text{Collision Count}}{\text{Packet Transmitted}}$ and tabulate the results in the different cases.

Case #1: Two transmitting nodes						
Retry Limit	Throughput N1 (bps)	Throughput N2 (bps)	Aggregate Throughput(bps)	Collision Count	Packet Transmitted	P_c
0	0	0	0	26980	26980	1
4	55	51	106	7104	16624	0.427
6	71	65	136	2548	14647	0.173

Table 4-9: Simulation Results with 2 transmitting nodes

Case #2: Three transmitting nodes							
Retry Limit	Throughput N1 (bps)	Throughput N2 (bps)	Throughput N3 (bps)	Aggregate Throughput (bps)	Collision Count	Packet Transmitted	P_c
0	0	0	0	0	40470	40470	1
4	26	26	27	79	12234	19348	0.632
6	43	41	37	121	4969	15726	0.316

Table 4-10: Simulation Results with 3 transmitting nodes

Case #3: Four transmitting nodes								
Retry Limit	Throughput N1 (bps)	Throughput N2 (bps)	Throughput N3 (bps)	Throughput N4 (bps)	Aggregate Throughput (bps)	Collision Count	Packet Transmitted	P_c
0	0	0	0	0	0	53960	53960	1
4	15	15	14	16	60	16942	22293	0.75
6	28	27	26	26	107	7202	16756	0.42

Table 4-11: Simulation Results with 4 transmitting nodes

We carry out simulations with different settings of Retry Count. The final results are plotted below. When Retry count is set to zero, all packets collide even when just two nodes are

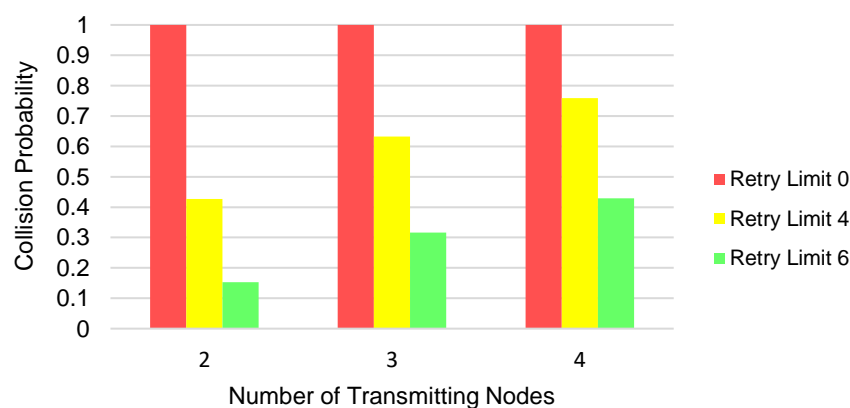

Figure 4-6: Collision probability vs Number of Transmitting Nodes

transmitting. With retry count set to 0, the node attempts a packet transmission. If it fails, there is no retry and the packet is dropped. Recall, that in s-Aloha the transmitter does not back off

before the first transmission attempt for a packet. With backlogged queues, the two transmitting nodes keep attempting at each slot. This leads to continuous collisions.

When the retry count is set to 4 (or 6) a transmitting node back off per the exponential backoff algorithm, before every retransmission. The back off algorithm is explained in section 3.2.3. Hence there is an element of randomness in packet transmissions at each slot. Nodes may or may not transmit. The probability of transmission at a particular slot reduces as the Retry Count is increased. Hence, we see lower collision probabilities for Retry count of 6.

Advanced: s-Aloha works as expected only if the slot time is greater than transmission time plus the propagation delay. What happens when slot length is lower than this limit? Under this condition a new slot is available for transmission even before completion of an existing packet transmission. Thus, if an idle node completes its back off before the transmission (where transmission time equals $T_{tx} + \Delta$) of one another node is complete, it will attempt to transmit at the start of a new slot. The two packets collide and are lost. One would therefore expect higher collision probabilities with smaller slot lengths. NetSim simulation results for 2-node transmitting case with slot time, 250 ms is given below

Retry Limit	Throughput N1 (bps)	Throughput N2(bps)	Aggregate Throughput(bps)	Collision Count	Packet Transmitted	P_c	P_c (Ideal slot time)
0	0	0	0	26666	26666	1	1
4	20	20	40	14102	17696	0.797	0.427
6	45	46	91	6987	15109	0.462	0.153

Table 4-12: Simulation Results with slot time vs collision probability

Observe the significant increase in collision probability when the slot time is set lower than the ideal slot time. Next, we fix the retry count at 6 and vary the slot time from 50 ms to 750 ms in steps of 50 ms. In the plot below showing collision probability vs. slot time, we again observe how low slot times lead to higher collision probabilities.

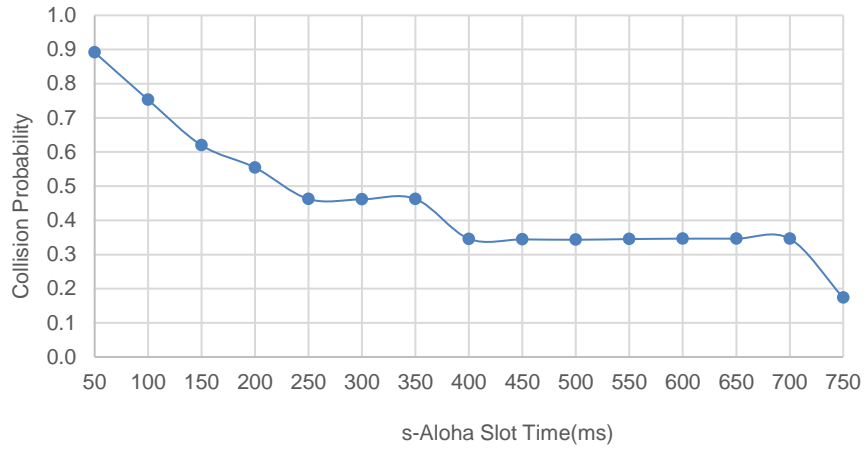

Figure 4-7: Collision probability vs slot time

5 Limitations

- Users cannot model buoy nodes, behaving as network sink(s) to collect data which can then be transmitted, via Radio Frequency (RF), to a nearby boat, or satellite
- Link layer ACKs are not modeled in s-Aloha
- There is no Guard time between slots in s-Aloha
- Dynamic routing protocols are not supported
- Doppler shift on account of transmitter and/or receiver motion is not accounted
- UWAN cannot connect to an “external” network; it operates stand alone.
- All devices are assumed to be time synchronized.
- Models for simulating multipath fading are not currently available.

6 References

- [1] A. B. Coppens, "Simple equations for the speed of sound in Neptunian waters," 1981.
- [2] H. U. Yidliz, V. C. Gungor and B. Talvi, "Packet Size Optimization for Lifetime Maximization in Underwater Acoustic Sensor Networks," *IEEE Transactions on Industrial Informatics*, 2019.
- [3] M. Stojanovic and J. Preisig, "Underwater Acoustic Communication Channels: Propagation Models and Statistical Characterization," *IEEE Communications Magazine*, 2009.
- [4] D. E. Lucani, M. Medard and M. Stojanovic, "Capacity Scaling Laws for Underwater Networks," 2012.
- [5] M. Stojanovic, "On the Relationship Between Capacity and Distance in an Underwater Acoustic Communication Channel," in *WUWNet*, 2006.
- [6] R. J. Urick, *Principles of Underwater Sound*, Peninsula Publishing, 1983.